

USER MANUAL
EPURE ESCAPE RANGE
2023



INFORMATION

ELECTRIC MOTION
ZAC VIA DOMITIA
280 Rue du Trident
34740 VENDARGUES
FRANCE



www.electric-motion.fr



Projet cofinancé par le Fonds Européen de Développement Régional

This information is not contractual and can be changed without any notice.

Table of contents

1. 1. Manual introduction	6	3.8 Parts and consumables.....	13
1.1 Important message from <i>Electric Motion</i>	6	3.9 Operation under extreme conditions.....	13
1.2 About this manual	7	3.10 Reception of the motorcycle	13
2. Safety instructions	8	4. Vehicle identification	14
2.1 Regulatory use	8	4.1 Chassis number	14
2.2 Operating information	8	4.2 European certification label	14
2.3 Protective clothing	9	4.3 Engine number (references).....	14
2.4 Environment.....	9	4.4 Battery number (references).....	14
2.5 Location of important labels	10	5. Overall view of the vehicle	15
2.6 Fire hazard.....	10	5.1 Right view	15
2.7 Fall or accident	10	5.2 Left view	15
3. Important observations and general information.....	11	6. Technical data	16
3.1 Emission information	11	6.1 Engine.....	16
3.2 Manufacturer's warranty and legal warranty	11	6.2 Tires.....	16
3.3 Vehicle range.....	11	6.3 Fork	16
3.4 Transport of the vehicle	12	6.4 Shock absorber	16
3.5 Spare parts and accessories	12	7. Controls and Components.....	17
3.6 Lifetime optimization	12	7.1 Front/rear brake system and adjustment	17
3.7 Power supply.....	13	7.2 Throttle grip	17
		7.3 Lighting system.....	18

7.4 Turn signals	19	9.9 Cleaning the motorcycle.....	40
7.5 Left-hand side handlebars switches	20	9.10 Motorcycle storage	41
7.6 Main magnet switch and map button	20	10. Setting the motorcycle controls	42
7.7 Side stand	21	11. Maintenance	44
7.8 Dashboard	21	11.1 Raising the bike on a stand.....	44
7.9 Battery pack	22	11.2 Front fork dismounting – mounting	44
7.10 Battery charger	25	11.3 Clean the fork.....	46
8. Commissioning.....	26	11.4 Chain tension adjustment	46
8.1 Preparation on receipt of the motorcycle in a shipping box .	26	11.5 Shock absorber setting (EXCEPT Epure Race)	47
8.2 Instructions for initial commissioning	27	11.5.1 Hydraulic setting.....	47
8.3 Battery Charging Procedure	28	11.5.2 Spring pre-load adjustment.....	47
9. Operating the motorcycle	31	11.6 Shock absorber setting (Epure Race)	48
9.1 Inspection before use.....	31	11.6.1 Rebound setting	48
9.2 Starting the motorcycle.....	31	11.6.2 Spring pre-load adjustment.....	48
9.3 Motor’s behavior adjustment	33	11.7 Removing and refitting the front mudguard	49
9.4 Braking	37	11.8 Auto-setting.....	49
9.5 PRB (EPURE/ESCAPE).....	37	11.9 ON road display setting	50
9.6 Anti-Reverse by EM	38	11.10 Dismantling and reassembling the handlebars	51
9.7 Clutch (RACE model)	39	11.11 Dismantle and reassemble the motorbike cover	52
9.8 Stopping your motorcycle	40	11.12 Maintenance	54



12. Clutch	55
12.1 Clutch oil maintenance (RACE)	55
INDEX	56

1. 1. Manual introduction

1.1 Important message from *Electric Motion*

Congratulation and thank you for purchasing an *Electric Motion* electric motorcycle. We welcome you in our family devoted to electrons.

Electrical production on national grids becoming more and more clean and renewable, we are proud to provide you with an alternative to internal combustion engines and therefore allowing you to take part in solving the serious challenges we all face with air pollution and global warming.

The use of this electric motorcycle requires you to respect some recommendations and precautions in order to enjoy all the advantage that can offer this new clean alternative.

It is therefore imperative to read this manual which contains all the necessary information for preparing for the motorcycle first use, on how to operate it, on how to maintain the motorcycle and on what checks need to be carried. Furthermore, this manual contains all the information to prevent yourself and third parties from risks and accidents linked to the use of an electric motorcycle.

Because the *Electric Motion* team is continuously improving their products, it is possible that some information contained in this manual might change due to updates. If you have any doubt, do not hesitate to check our website www.electric-motion.fr/en/ and download the latest version of the manual. Thus, no juridical claim can be conducted based on the information contained in this manual.

The content of this manual will allow you to maintain your bike in perfect working order in the most secure way possible.

1.2 About this manual

Keep the user manual in an easily accessible location, so that it is close to hand when required.

The "right" and "left" designations refer respectively to the right or the left of the rider when he is in the driving position.

To illustrate all the maintenance operations, or to clearly designate elements of the motorcycle, pictures were used. Since *Electric Motion* is constantly improving their product, it is possible that certain parts of the motorcycle will change in geometry or in colors. However, this does not affect the operational processes explained in the manual.

The owner's manual is an important part of the vehicle. It must be transferred from owner to owner upon resale of the vehicle.



In this manual, the **CAUTION** designation will alert you to an object or situation that may cause injury to you or a third party or also damage your vehicle.

2. Safety instructions

2.1 Regulatory use

The *Electric Motion* motorcycles have been designed and built to withstand mechanical stress resulting from road, trial and trial touring use.

EM bikes are not intended for Pit Bike, Enduro, Motocross, Freestyle use.

EM disclaims all responsibility for the above-mentioned use.

They have been assembled in order to be homologated (EU) and thus has all the equipment necessary to be ridden on roads opened to traffic. It is therefore forbidden to modify the accessories installed as standard on the motorcycle. *Electric Motion* cannot be held liable for any modifications to the accessories installed on the motorcycle.



Use only *Electric Motion* parts. These parts have been tested and approved by *Electric Motion*. Under no circumstances should you try to replace the motorcycle components such as the battery pack or the engine with components of another brand, at the risk of causing irreversible damages to your vehicle.

Electric Motion does not assume any responsibility for the adaptation of unapproved parts.

2.2 Operating information

In order to guarantee a safe operation of the motorcycle, it is forbidden to carry out any modification on the vehicle.

For example, it is formally prohibited to use the vehicle if the vehicle, or one of its components, hasn't been properly maintained or if it is used outside the scope of the intended use. It is also forbidden to open the motor or the battery pack.



Any modification carried out on the vehicle by the customer does not render *Electric Motion* liable and voids any form of manufacturer's warranty.



Do not use the vehicle under the influence of alcohol, any medicine that could alter your capacity to drive or illegal drugs, or if you are not physically or mentally able to drive.



When using the vehicle, some components will start moving (chain, wheels) and will become dangerous for the user. It is important to take the right measures to avoid any unnecessary risks.

2.3 Protective clothing

To reduce the risks of potential injury while riding an *Electric Motion* motorcycle, on road or off road, it is necessary to be equipped with all compulsory protective clothing.

For any kind of trip and for any person that will ride the motorcycle, it is necessary to wear the correct protective clothing (helmet, boots, gloves, trousers and jacket equipped with protective means).



Failure to wear safety clothing or wearing damaged safety clothing is a serious safety hazard and can result in serious injury or death.

Like the driver, the passenger must also carry all the necessary protective clothing when riding the motorcycle behind the driver.



Only use protective clothing that is in perfect condition and complies with the legal requirements of the country of use.

2.4 Environment

In order to guarantee the durability of motorcycle driving, it is necessary to respect the rules of goodwill on the road with other users, motorized or not. Ensure that you remain within the legal framework of the use of a motorcycle. Be respectful to the environment and road users and take into account the rights of other road users.

When the motorcycle parts are disposed of, be sure to comply with the recycling regulations of the country of use, in particular the battery pack.



Electrical components (motor, battery, etc.) and electrical appliances (battery charger) should not be treated as household waste and require strict recycling.

If you have any questions about the rules for recycling, contact *Electric Motion* Customer Service.

2.5 Location of important labels

Safety instructions are present in various places on the motorcycle. They allow the user to protect himself from certain risks associated with the maintenance of the motorcycle and to preserve the physical integrity of the motorcycle, its driver and its passenger.



1	Manufacturer label
2	Warning label

 Never remove the warning labels. They allow the driver to avoid getting injured by exposing himself to a danger that cannot be recognized without the presence of these stickers.

2.6 Fire hazard

As long as the battery pack remains in good working condition, there is no particular fire hazard on this vehicle. However, if the vehicle catches fire, it is necessary to inform the fire brigade that the fire originated from an electric vehicle with a lithium-ion battery.

 When the battery pack is damaged, it may present a fire hazard. If the battery pack is damaged, contact *Electric Motion* customer service promptly.

2.7 Fall or accident

A fall or a road accident can damage the motorcycle significantly. After a fall or an accident, make a complete inspection of the vehicle to make sure that the users of the motorcycle do not expose themselves to any danger before riding again.

 A vehicle damaged for any reason may become a danger to users. In case of damage to the electrical components, please contact the *Electric Motion* customer service promptly.

3. Important observations and general information

3.1 Emission information

The development of its motorcycles by *Electric Motion* has made it possible to obtain a zero-emission vehicle that does not emit any harmful particles for the environment. Therefore, it has no exhaust or evaporative emission.

This motorcycle does not use gasoline, engine oil or any other liquid fuel.

3.2 Manufacturer's warranty and legal warranty

All the work detailed in the maintenance guide must be carried out exclusively by a professional in order to retain the warranty right.

The warranty is cancelled in the event of damages resulting from manipulation or modification on the vehicle made by a person not certified by *Electric Motion*.

For additional information on the manufacturer's warranty and how to obtain it, contact *Electric Motion* customer service.

3.3 Vehicle range

The range of the motorcycles is defined as the distance the vehicle travels on a single full charge of the battery.

It is then easy to understand that the range of the vehicle depends on how it is used. The more conservative you ride, the better range you can expect from your motorcycle.

There are many factors affecting the range, such as speed, acceleration, number of regenerative braking, weather conditions, tire pressure and payload.

For the first use of your motorcycle, you are advised to remain cautious, so you become fully aware of the range of your vehicle according to your driving style.

After you were able to make your own idea about the potential of the model, you can adapt your driving style to the range you would like to achieve.



The range values in this manual are measured according to different standards, which may vary depending on the country of use.

In order to improve the range of your vehicle, all these characteristics must be considered:

Low range	Important range
Travelling at high speed	Low speed travel
Bad road condition	Good road condition
Important elevation	Low elevation
Aggressive driving	Smooth driving
Important payload	Low payload
Cold temperature	Hot temperature
Adverse weather conditions	Good weather conditions
Under inflated tires	Properly inflated tires
Poor general maintenance of the motorcycle	Good general maintenance of the motorcycle

3.4 Transport of the vehicle

The transport of the motorcycle can be carried out with the help of an approved trailer or a utility vehicle.

It is important to ensure that the motorcycle is securely fastened before transporting it on the public road. The use of certified straps to maintain the motorcycle is recommended to avoid any accidents related to the loss of the vehicle on public roads.

3.5 Spare parts and accessories

For safety reasons, we recommend that users of Epure only use spare parts and accessories authorized and recommended by *Electric Motion* and have them fitted by a professional.

The company *Electric Motion* will decline any responsibility in case of equipment deterioration caused by products not approved by the brand.

For information on spare parts and their installation, contact the *Electric Motion* customer service or on our website www.electric-motion.fr/en/.

3.6 Lifetime optimization

In order to optimize the life of the vehicle, it is important to perform the maintenance tasks listed in the user manual at the right mileage/time of use.

Maintaining maintenance intervals is important to keep a vehicle in good working condition and to avoid early wear.

Furthermore, incorrect adjustments of the chassis results in premature wear of the vehicle.

It is important to refer to the vehicle maintenance manual.

3.7 Power supply

Model	Epure	Epure Race	Escape	Escape R
Voltage	Min: 42V / Nom: 50.4V / Max: 58.8V			

It is possible to mount / dismount the battery pack during some maintenance process. (👉 <https://www.electric-motion.fr/en/my-em-en/instruction-videos>).

3.8 Parts and consumables

To maintain your vehicle, it is important to use parts and consumables (lubricants and maintenance products) in accordance with the specifications given in the user manual.

3.9 Operation under extreme conditions

The motorcycles of Electric Motion are not sensitive to water drops and rain. However, care must be taken to ensure that the water level on the road being ridden does not exceed the foot-rest height.



In the event of the rider being stopped on a road with a high level of water, it is necessary to turn off the motorcycle to avoid a short circuit or a breakdown.

The motorcycles can be used over a wide range of temperatures: -15°C to +55°C (5°F to 131°F).



The battery life of the different models depends on the operating temperature:

Operating temperature (°C)	-15°C (5°F)	-10°C (14°F)	0°C (32°F)	25°C (77°F)	40°C (104°F)	55°C (131°F)
Decrease in battery range	-30%	-25%	-15%	-0%	-3%	-4%



Use of the vehicle in extreme conditions (sand, mud) leads to premature wear of the motorcycle's consumables (chain, brake pads, various bearings). It is then necessary to carry out the checks and the maintenance operations more often than prescribed in the manual of use.



High continuous solicitation ride can lead to a power and speed limitation to manage internal temperature. In this case, reduce the solicitation to continue ride.

3.10 Reception of the motorcycle

When receiving your motorcycle, it is necessary to perform some operations to make the motorcycle usable (assembly of parts protected during transport). Please refer to the corresponding chapter (👉 8).

4. Vehicle identification

4.1 Chassis number

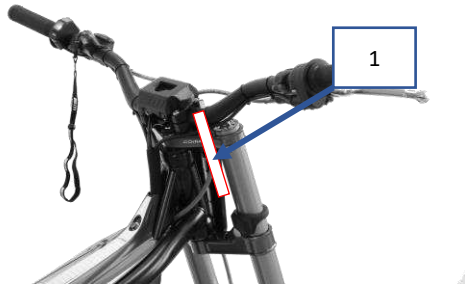

4.2 European certification label

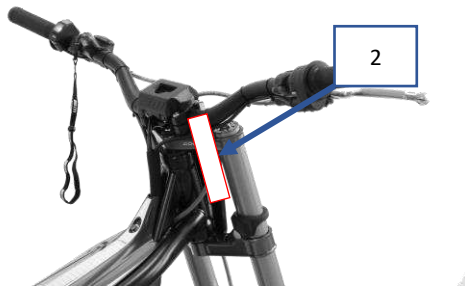

4.3 Engine number (references)

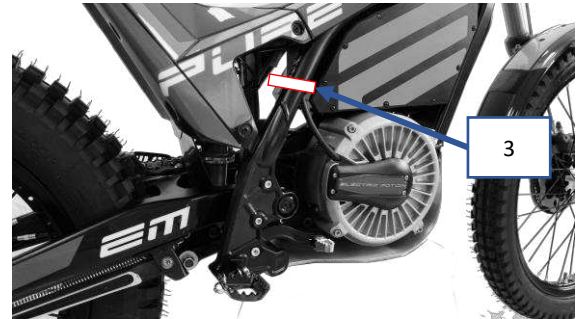

4.4 Battery number (references)

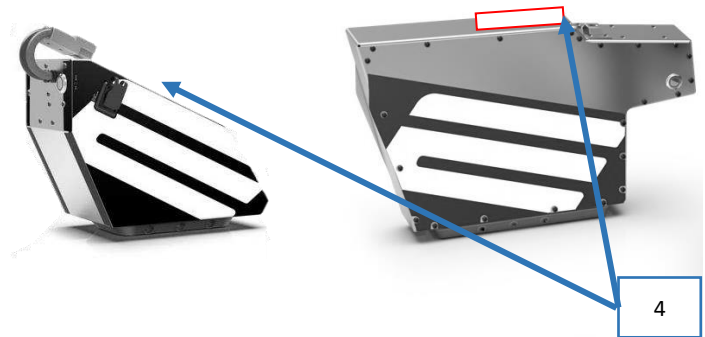

5. Overall view of the vehicle

5.1 Right view



5.2 Left view



6. Technical data

6.1 Engine

Motor type	BLDC permanent magnet motor
Nominal power	6 kW
Peak power	11 kW
Maximal torque	600 N.m
Engine max speed	6500 RPM
Cooling system	Air

6.2 Tires

Model	Epure	Epure RACE	Escape	Escape R	COMP
Tyres	MICHELIN X11				

6.3 Fork

EPURE / ESCAPE: TECH Steel \varnothing 39 mm
 EPURE Race / ESCAPE R: TECH Aluminum \varnothing 39 mm

6.4 Shock absorber

Model	Epure	Epure Race	Escape	Escape R
Rear Suspension	R 16 V	Reiger	R 16 V	R 16 V

7. Controls and Components

7.1 Front/rear brake system and adjustment

The front brake lever is located on the handlebars right-hand side.
The rear brake pedal is located near to the right foot peg.



 Before each use, check the condition of the brake system. A faulty brake system makes you vulnerable as well as the other road users.

7.2 Throttle grip

The throttle grip is located on the handlebars right-hand side.



 Before each use, check that the throttle grip rotates and returns correctly to prevent any accident.

7.3 Lighting system

The headlight is installed on the forks located on the vehicle front and the taillight is installed on the rear subframe of the vehicle. *Electric Motion* advises to always have the lights turned on.

Headlight:



 The headlight can get hot when it is turned on.

Taillight:



 Make sure that the lighting system is always in working order. Riding without a lighting system does not allow other users to see you and does not allow you to see other users. It is mandatory to have a lighting system in good working order.

7.4 Turn signals

Front turn signals:



Rear turn signals:

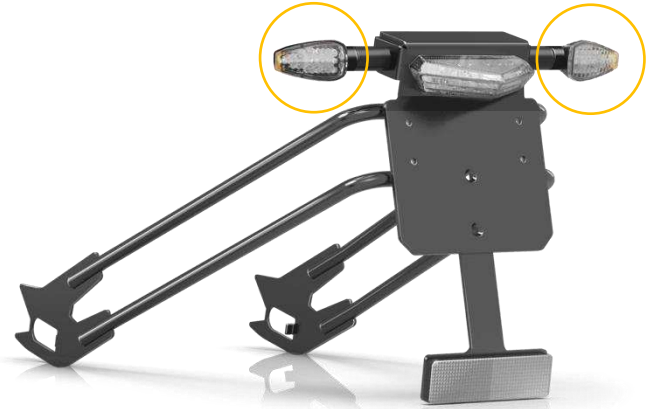

7.5 Left-hand side handlebars switches

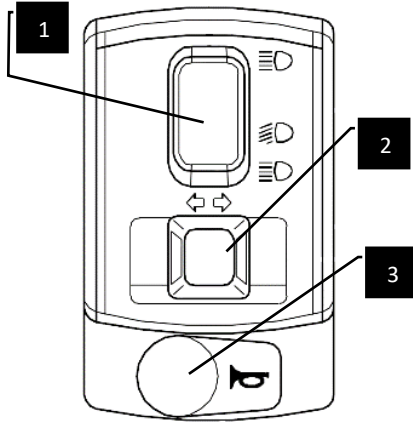

On the left side of the handlebar, the main magnet switch is lighting when the bike is ON and when the battery is ON



When you switch OFF the battery, this red LED will be OFF
The total extinction of this led can take a few minutes, but the battery is well shut.

7.6 Main magnet switch and map button

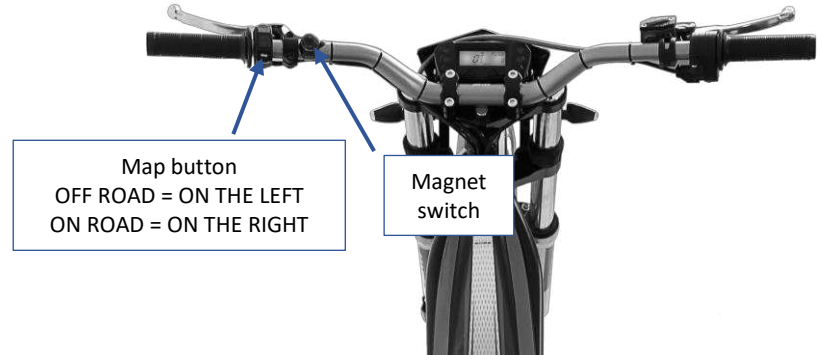

On the left side of the handlebar, the magnet switch is needed to switch ON the motorcycle.

When the magnet is installed, the motorcycle is ON.

Cluster switch ON.

Now you just have to push the map button to select the map needed.

7.7 Side stand



7.8 Dashboard

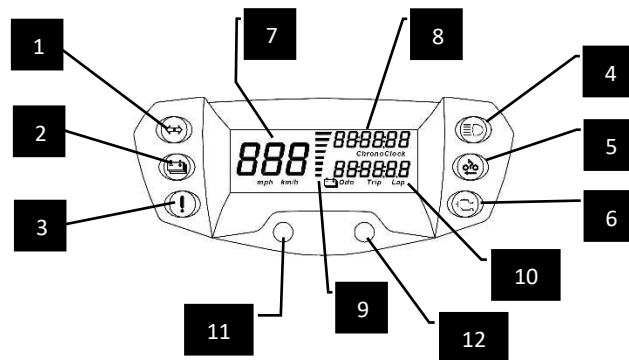

1	Right and left turn signals indicator
2	Low battery Indicator
3	High temperature indicator
4	Headlight high beam Indicator
5	"Ready to ride" Indicator
6	System warning indicator
7	Speed (km/h à mph : 10sec on MODE button)
8	Maps indicator
9	Battery charge indicator
10	Total distance traveled or two partial trips
11	Adjust button (MODE)
12	Battery charge indicator (SET)

7.9 Battery pack

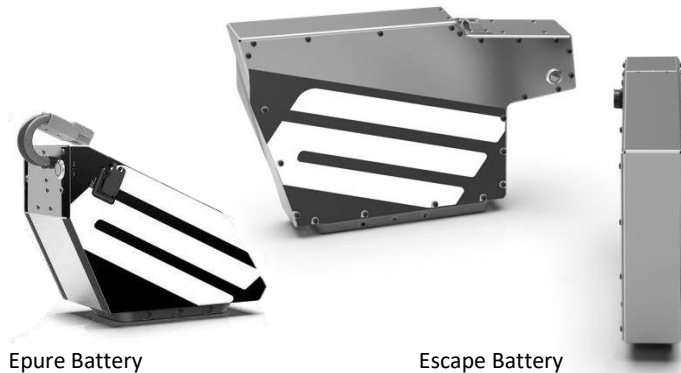

The battery is inside the battery pack. The casing of the battery pack makes it possible to protect all the cells composing the battery against the aggressions of the external environment. Up to a certain limit, the battery pack is protected against splashes of water, dust, and other harmful elements for the battery (rain, driving in dry weather). However, the user must be careful not to use the motorcycle under extreme conditions, otherwise the vehicle may be damaged irreversibly (full immersion of the motorcycle).

The battery pack uses a set of lithium-ion cells assembled in series. These elements have been tested to obtain the best performance while maintaining maximum reliability.

It is important to note that the maximum capacity of the battery will be obtained after **about 10 cycles of full charge / discharge of the vehicle.**



The battery pack is dimensioned to achieve the best possible reliability / performance ratio. It is possible, however, that certain maintenance operations will be carried during the lifetime of the vehicle.

All work on the electric components of the motorcycle, and especially on the battery pack, is accompanied with risks of causing electric arcs if precautions are not taken. Working on the electric components of the motorcycle requires special training, qualifications, and tools.

Therefore, all work that is not explicitly described in this manual, and which concerns an electronic device, must be done only by an *Electric Motion* qualified electrician.

Do not open the motor or the vehicle battery pack. If there are any problems with these items, contact *Electric Motion* Customer Service.



When receiving the motorcycle, it is important to charge the battery pack according to the recommended battery charging procedure.



Be sure to turn off the motorcycle after each use or whenever the motorcycle is not used for an extended period. Make sure that all the lights are turned off when the ignition key is switched off.

 Please check the battery housing state after use and above all after a fall.

Battery management system (BMS)

The BMS (battery management system) is an internal component of the battery pack. It allows the management and the control of all the battery cells during charging and discharging of the vehicle. The BMS therefore protects the battery with the help of an electric safety relay.

The main roles of the BMS are therefore:

- Prevent the charge of the battery when the outside temperature is below 0°C (32°F).
- Prevent the charge of the battery when the outside temperature is above 45°C (113°F).
- Prevent the discharge of the battery when the outside temperature is below -15°C (5°F).
- Prevent the discharge of the battery when the outside temperature is above 55°C (131°F).
- Allow a uniformly distributed charge of all cells in the battery pack.
- Optimize charging and discharging of the battery.

 The BMS is a vital component of the motorcycle for its good working order. Do not try to modify it by any means.

Battery charge level

The battery pack is connected to the dashboard and therefore allows the display of the state of charge directly on the dashboard.

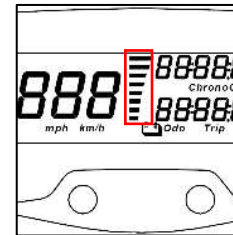

The battery charge indicator is composed of 8 bars indicating the range of the motorcycle. As you approach the last bar, the low battery indicator LED lights up indicating that you reached a low battery charge level:

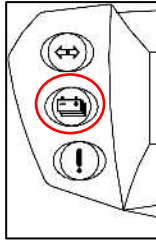

 When this indicator light turns on, the battery is in low voltage, which means that the motorcycle can cut off in order to prevent any damages to the cells.

It is important to avoid excessive speeds and abrupt accelerations when the low battery indicator lights up and to reach a charging station as fast as possible.

 If you plan on using any highway and depending on the battery charge left and the distance left to travel, check first that there is a charging station on your way or that there is a highway exit, so you don't get stranded.

An option exists where the battery level indicator is located on the center of the handlebar (option OFF ROAD KIT).

Battery level indicator OFF ROAD version (hors UE)



The battery level indicator goes in sleep mode after 10 second, to display again the battery percentage level, you must push the main button located directly on the center of the display.

To have a precise value of the battery percentage, it is necessary to do not ride with the bike for almost 1 minute (bike still ON), and then push the main battery level button to see the percentage.

It is possible that the display switch it on during ride, do not take care of the displayed value.

 Not any high pressure washing on this display.

It is important to avoid excessive speeds and abrupt accelerations when the battery level is under 20% and to reach a charging station as fast as possible.

7.10 Battery charger

The Epure model can be delivered with 3 different types of battery chargers with different charge speeds: a 10A charger, a 15A charger and a 25A charger.

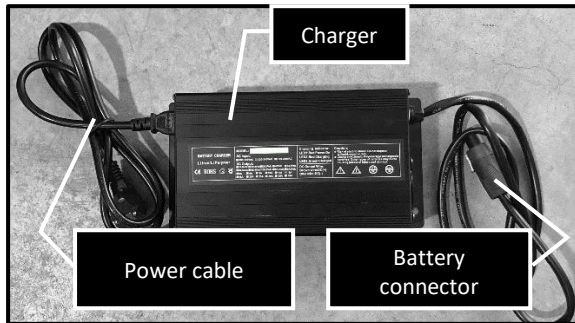

 In a wet environment, there is a risk of creating electric arcs when charging the vehicle. The battery charger is not humidity-proof. It is important to use the battery charger in a dry environment and to ensure that no liquid is spilled on the charger.

 In case of incorrect handling of the battery charger, the safety of the user is not guaranteed.

 Use the battery charger only with an *Electric Motion* battery pack.
Use the battery charger only by connecting it to a safe electric socket in accordance with the regulations in force in the country of use. Do not use an adapter or extension cord other than the one already presents on the charger.

 Do not modify the battery components by any means. Check that the charger's power cable and battery cable are in good condition before each use.

8. Commissioning

8.1 Preparation on receipt of the motorcycle in a shipping box

On receipt of the vehicle, the handlebar is disassembled. It is therefore necessary to assemble all these components in order to use the motorcycle.

Assembling the handlebars upon receipt

The handlebars are supplied in the box accompanying the motorcycle and must be assembled in accordance with the following procedure:

- Unscrew the 4 M8 screw of the upper handlebar holder and remove them.
- Install the handlebar like the picture below.



- Install the again the handlebar holder and the 4 M8 screw with a 6mm Allen key, tightening them at 14 Nm and taking care of the position of the handlebar.



- Take care of the wires during mounting.

8.2 Instructions for initial commissioning

Before using the motorcycle, the user must carefully read the entire user manual.

Because driving an electric motorcycle is a new driving experience, a period of adaptation is necessary to become familiar with the new sensations that it brings before being fully confident when traveling on roads open to others traffic users.

Before using the motorcycle on the road, ride it in a secure area to get acquainted with riding an electric motorcycle. Try all settings on the vehicle and get familiar with the results.

To maintain control of your vehicle, always hold the handlebars with both hands and keep your feet on the foot pegs.



Do not use the vehicle if you are not in full possession of your means.

Adapt a cautious behavior for you and other road users.

Do not exceed the vehicle's permissible payload.

Do not leave your vehicle unattended (risk of theft).



An electric motorcycle makes no noise when it is turned on, do not let yourself be caught by surprise.



When the battery level is low, the motorcycle keeps working on an energy saving mode. The vehicle power is reduced but it is in no

way a breakdown. After charging the battery, full power will be available again.



When the battery has been over discharged, the motorcycle will not start charging straight away. It is necessary to wait until the vehicle automatically start charging again.

8.3 Battery Charging Procedure

The procedure for charging the vehicle being meticulous, it is important to be familiar with this procedure before the first charge of the battery.

The battery must be charged over a temperature range from 0°C to 40°C.



For a better battery life, it is advised to not charge the battery directly after riding, but to wait 30min.



Due to the strong current involved, electrical arcs may occur when connecting the connector to the battery.

Use only the charger supplied with the motorcycle to charge the battery. This charger is designed to operate only with a lithium polymer battery.

Always place the charger on a flat, solid surface in a dry, ventilated area.

Never cover the charger while charging the battery, otherwise it may interfere with its ventilation and cause the charger to overheat.

Charging Procedure for 10A, 15A and 25A chargers

- Stop and switch off the motorcycle (🔑 9.8).

- Plug the charger on the wall plug.



- Only for 25A charger, switch on the switch located on the back of the charger.
- Verify that the LED 1 & 2 are like the below picture:



- Plug the charger to the battery

Epure

Escape



Left side

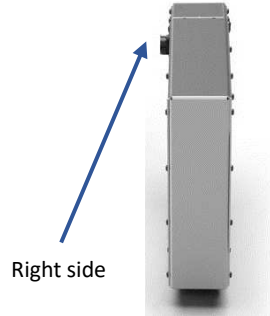

Right side

 When the connector is inserted in the battery, a “click” can be heard indicating that the battery has switched to a charging mode. The battery will then start charging automatically. When switching to charging mode, both charger’s LEDs will be red.

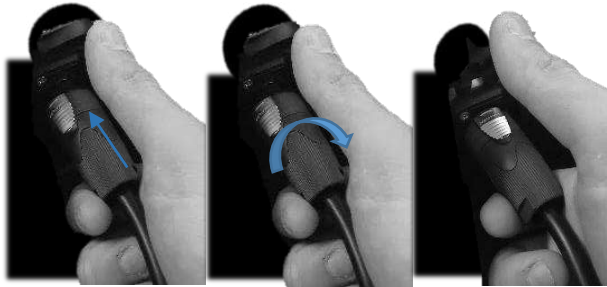

- When the charge is finished, the LED2 will go to Green like the below picture.



To connect the charger to the battery:

- Slide the connector

THEN

- Turn the connector to the right

- Disconnect the charger from the battery.

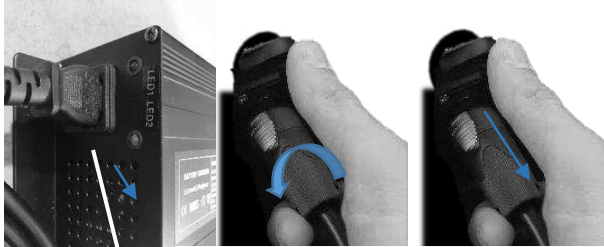

Pull back the metallic part of the connector, then turn to left, then pull the connector

- Only on 25A charger, switch of the switch located on the back side
- Unplug the charger from the wall plug.



Remark : If any issue occurs during the charging process, please repeat the process **from the beginning** in order to set the battery on charge

When the motorcycle is charging, do not turn on the motorcycle using the ignition key, it would immediately stop the charging process.

Take care to do not put any metal object or water inside the battery charge plug on the battery.

Do not leave the charger connected to the battery after charge.

In the event of abnormal symptoms:

- LED 2 remains green when connected but does not turn red (the battery is not charging)
- Incomplete charge (< 90%)
- Noise
- Excessive heating

Please stop using or charging the battery and contact your official EM dealer as soon as possible.

9. Operating the motorcycle

9.1 Inspection before use

It is important that the user of the motorcycle checks that the condition of the vehicle is intact and that it can be safely used before each journey.

In order to be used, the motorcycle must be in perfect technical condition.

The pre-ride inspection consists of:

- Check the state of charge of the battery.
- Check that all the screws and bolts are tight.
- Check for correct function of all the electrical equipment.
- Check that the brake system is in proper condition (brake fluid, brake pad wear and system operation).
- Check the condition and pressure of the tires.
- Check the condition of the final drive system (chain and sprocket, lubrication).
- Check for correct function of all the control devices.



If there are any abnormalities on the motorcycle during the pre-trip inspection, do not take any risk, contact *Electric Motion* customer service

9.2 Starting the motorcycle

- Switch on the battery by pushing main switch

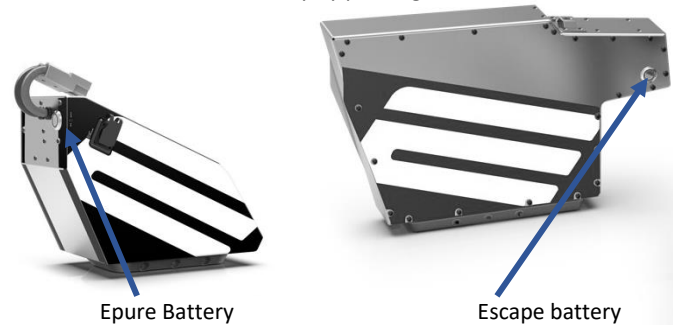

- Install the magnet on the base.



- The motorcycle is now ON, in security map.



- Then push the map button to be in the first map and change then as desired with map button.



- The Bike is now ready to ride.

The motorcycle should be at a complete stop before turning it on.

When the bike is in working order, it does not make any noise!

Under no circumstances should the kickstand be unfolded when the motorcycle is used.

9.3 Motor's behavior adjustment

The motorcycle is equipped with 3 driving maps which you can select by the map button.

PUSH - MAP 0 (WHITE LED)

The Map 0 is a security map, you have to push the map button to select the Map 1

ESCAPE / ESCAPE R

1 – TREK (GREEN LED)

Trek mode is dedicated to Trek use, acceleration is smooth up to the max speed

2 - TRIAL 1 (BLUE LED)

TRIAL 1 map is dedicated to wet condition, acceleration is smooth up to max speed.

3 - TRIAL 2 (RED LED)

TRIAL 2 map is dedicated to trial use, in dry condition and 100% of the performance of the motorcycle.

Using the TC – TRACTION CONTROL (ESCAPE / EPURE)

The TC (Traction Control) is developed for helping pilot in hardest conditions to avoid slipping.

TC is mainly working at low / mid rpm, with torque and speed calculation/regulation for 100% traction efficiency!

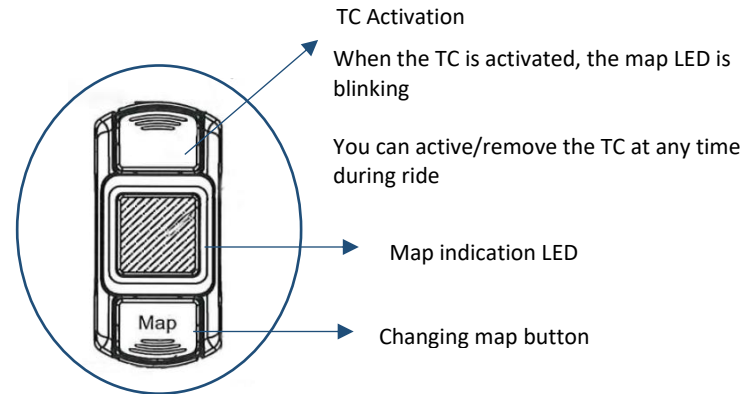

EPURE / EPURE Race

1 - TRIAL 1 (GREEN LED)

TRIAL 1 map is dedicated to hard conditions and where traction is needed. Acceleration is smooth up to max speed.

2 - TRIAL 2 (BLUE LED)

TRIAL 2 map is dedicated to dry trial use, more powerful and more response for trial use.

3 - TRIAL 3 (RED LED)

TRIAL 3 map is the most powerful map of the motorcycle with 100% of the performance.



Driving too fast or aggressive can cause overheating problems.



Make sure you are aware of the motorcycle different behaviors when changing maps before using them in traffic/open roads. These changes in behavior could surprise an uninformed driver.

Using the FRB – Not progressive engine braking

(ESCAPE/EPURE)

When pressing the button (grey on the bike), an engine brake will be activated, and slow down the bike. The intensity depends on the speed of the motorcycle.

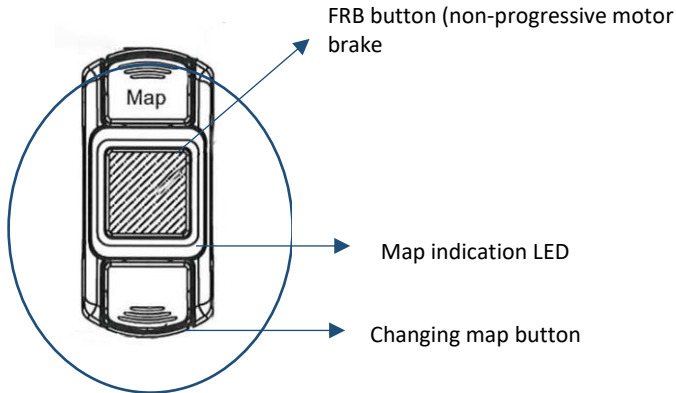

Using the TKO - Engine speed (EPURE Race / ESCAPE R)

The EPURE Race and ESCAPE R is equipped with an engine speed activation button located on the left side of the bike (see picture below). It is deactivated as standard.



 When you receive your motorcycle, a yellow sticker will be on this button, please read the manual before using it, it is a button for OFF ROAD use ONLY.

To activate the latter, you need:

1. Turn on the motorbike
2. Activate the rpm by turning the button to ON
3. When the button is turned on, the engine speed is not fully activated, **you must change the MAP to make it fully operational.**
4. Once the MAP change is done, your motorcycle has the engine speed activated

To deactivate the engine speed, simply switch the button back to OFF.

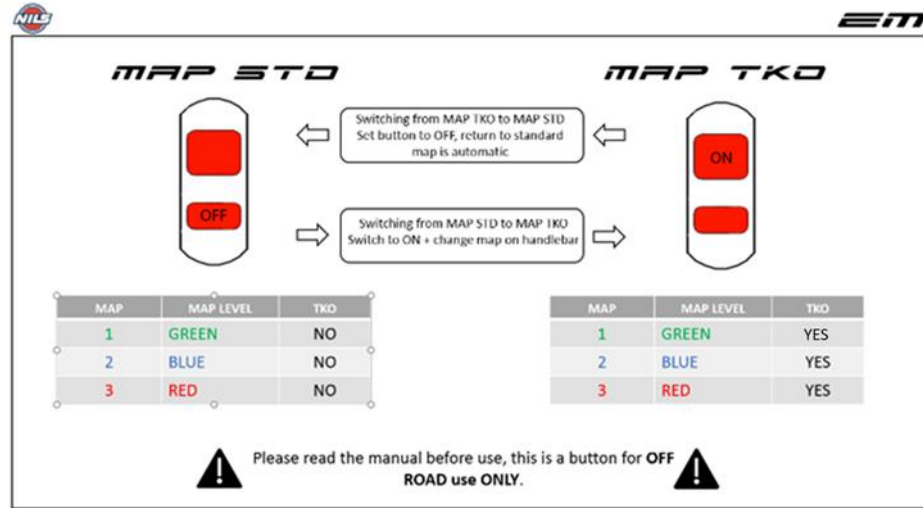

9.4 Braking

The front brake lever, located on the right-hand side of the handlebars, brakes only the front wheel.

The rear brake lever located near to the right foot peg brakes the rear wheel.

The brake levers control the brakes when the lever is squeezed.

It is important to be fully aware of the motorcycle's braking capacities for safe driving on public roads.

To brake properly, under normal traffic conditions, first close the throttle. Then brake using simultaneously the front and rear brake levers for strong braking.



When braking, the throttle grip must be in the closed position (acceleration stopped).



Braking too strongly causes the wheels to lock and makes the motorcycle dangerously uncontrollable. It is necessary to adapt your braking to the situation and to the pavement condition.



Check the condition of the brake system before each use. A wet or dirty brake system reduces braking performance. Clean and degrease the system if grease or dirt is present.

If there is any doubt about the condition of the brake system, contact *Electric Motion* customer service.

9.5 PRB (EPURE/ESCAPE)

EM has developed the PRB (Progressive Regenerator Brake). When the pilot is not accelerating, the motor is not powered. If it is in freewheel, it is possible to regenerate the motor ; it allows to recharge the battery while acting as a motor brake. Therefore, this lever allows to manage the regeneration percentage.



Avoid using PRB intensively or extensively when battery is charged more than 90%



9.6 Anti-Reverse by EM

All the models integrate the Anti-Reverse by EM function.

This function helps you when you are in difficulty in steep slopes. When you cannot climb anymore, you can activate the anti-reverse as explained after, to heavily brake the rear wheel, allowing you to reposition yourself without having the bike rolling backwards.



The anti-reverse function is only functional when the magnet is on. Taking off the magnet will deactivate the anti-reverse function.

The function could only be activated at **low negative speed: from 0 km/h to - 3km/h.**

The activation depends on the motorbike model you have:

Epure/Escape:

Engage the **PRB** lever to activate the function: the rear wheel is immediately heavily braked.

You can release the lever as the function will stay on until the throttle is activated.

Epure Race/Escape R

Press the **FRB (or PRBR in option)** button to activate the function: the rear wheel is immediately heavily braked.

You can release the button as the function will stay on until the throttle is activated

9.7 Clutch (RACE model)

The RACE model is equipped with multi-dic clutch with hydraulic command who allow to uncouple the motor from the transmission.

It can be very useful for trial, but it can be dangerous for amateur rider.

When the lever is released suddently, the motorcycle will be very aggressive and dangerous.



9.8 Stopping your motorcycle

To turn off the vehicle, follow the procedure below:

- Remove the magnet switch from his support.
- Switch off the battery (the LED around the battery switch ignition will goes to OFF).
- Unfold the kickstand so it is down and lean the motorcycle on it. Make sure that the motorcycle is stable and on a hard and stable ground to avoid falling. Beware of where you park your motorcycle and if there is a slope or not, the motorcycle having no gear to stop it moving.



Do not leave your motorcycle unattended after use. After riding, some parts of the motorcycle may be hot, so be sure not to touch them before they are fully cooled to avoid any risk of burns.

9.9 Cleaning the motorcycle

The motorcycle must be cleaned with clear water. It is possible to use soap to clean it.

To clean your motorcycle, it is necessary to:

- Wash the motorcycle without insisting on the components vulnerable to moisture (electrical components, external controls, and external bearings).
- Rinse the motorcycle thoroughly with clean water.
- Dry the motorcycle, insisting on the electrical contacts.



Do not clean the handlebars directly with a high-pressure washer.



For the Epure, be sure to dismount the battery before cleaning.



Take care that the charge battery cap is well install on the charge connector on the battery.



If, by mistake, you forget to shut down the battery after use, or to not have the bike turn on but not use it for 5 hours, it will go in standby mode. This security shut down the relays and the battery level indicator, which implies the indicator will be off, but the battery in standby, so be sure to turn it off.



DO NOT CLEAN THE MOTOR SENSOR WITH HIGH PRESSURE WASHER.



DO NOT CLEAN THE BATTERY WITH HIGH PRESSURE WASHER.



DO NOT CLEAN THE CONTROLLER WITH HIGH PRESSURE WASHER.

9.10 Motorcycle storage

In case of long-term storage of the vehicle, it is important to apply additional measures.

It is necessary to:

- Clean the motorcycle correctly (👉 9.9).
- Raise the motorcycle using a bike stool or dirt bike lift stand (allowing the suspensions of the vehicle to be relieved) (👉 11.1).
- Park your vehicle in a dry place, where the temperature is between 10°C and 25°C, which is not subjected to excessive temperature variation and protected from UV radiation.
- Cover the motorcycle with a breathable cover.

Note: There is no special precaution to be taken to restart the motorcycle.

When storing your motorcycle, it is important to follow a strict procedure to protect the battery during storage:

- Place the battery pack in an environment not exposed to direct sunlight and at temperatures below 25 ° C.

- Adjust the battery level regarding the storage time desired

Storage time	< 15 days	>1 month
	100 %	60 %
Battery level advised		

Note: After long storage, the battery will be in deep sleep, to switch ON again the battery, you must make several ON/OFF ignitions to wake up the battery



The battery charge level should be checked monthly, recharge the battery if necessary with the supplied charger.



If the motorcycle does not start after the storage period, do not attempt to recharge the battery, and contact *Electric Motion* Customer Service immediately.



Make at least 2 discharge/charge per year.

10. Setting the motorcycle controls

It is important to find your place on the motorcycle before starting to drive. Being at ease on your vehicle makes it possible to travel safely on public roads and to have a fluid riding style.

To adjust your Epure motorcycle at your convenience, adjust the position of the motorcycle levers, mirrors, and handlebar position according to the following procedures:

Levers position adjustments

- The levers can be adjusted using a 5mm Allen key. Tightening torque of 8Nm.



- For the lever positioning, you have to adjust these 2 screws.

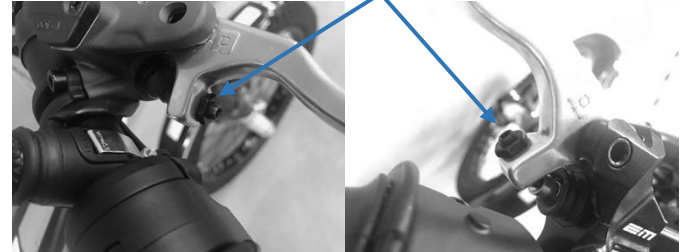

We recommend to not change the lever stroke.



Take care to frequently check your lever tightening.

Mirrors position adjustments

- Tighten the mirror with a 13mm tool





Handlebars position adjustments

The handlebars can be adjusted by untightening the 4 screws holding the handlebars on the bar mounts.

- Loosen the 4 screws with 6mm Allen.
- Adjust the Handlebar.
- Tighten the 4 screws evenly at 14Nm



 Please, frequently check that the screws holding the handlebars on the bar mounts are tight.

 Please, make sure that the handlebars are centered on the bar mounts.

11. Maintenance

Find all our maintenance videos on our web site:

<https://www.electric-motion.fr/en/my-em-en/instruction-videos>

11.1 Raising the bike on a stand



- Stop the vehicle (🔧 9.8).
- Raise the motorbike with an adjustable or non-adjustable stand, placing it under the engine block.

Ensure that you are on level ground to prevent the motorbike from falling off the stand.

Be careful when lifting the motorbike if you do not have an adjustable stand.

Ensure that the motorbike is securely held before releasing it to prevent the vehicle from falling.

11.2 Front fork dismounting – mounting

Dismounting

- Stop the motorcycle (🔧 9.8).
- Install the motorcycle on a stand (🔧 11.1).
- Remove the front plate.
- Remove the front mudguard (🔧 11.7).
- Dismount the front brake caliper with a 5mm Allen key.
- Carefully let the front brake caliper/offset bracket assembly hang from the end of the brake hose.
- Unscrew the upper and lower clamp with 4mm Allen key
- Loosen the upper tee bolts with a 4mm Allen key.
- Loosen the lower tee bolts with a 4mm Allen key.
- To remove the fork arms, carefully slide them out one by one, towards the ground.

Mounting

- Slide the fork inside the clamp one by one
- Adjust the position on the fork with the distance of 8mm



- Approach the upper and lower fork crown bolts loosely,
- Using a torque wrench, tighten the upper and lower fork crown bolts to 10 Nm.

- Mount back the front brake caliper/offset bracket assembly to the left fork arm. Use a 5mm Allen key to tighten to 20N.m. Be sure to put back the washers.

- After tightening the tees, tighten the wheel axle to 40 Nm.

Compress the fork gently (approx. 3 to 4 cm) and repeat the operation 2 to 3 times to center the wheel axle.



EPURE RACE – ESCAPE R FORK

- Tighten the upper screw clamp at **10 Nm up to contact.**
- THEN, tighten the lower screw at **10 Nm.**

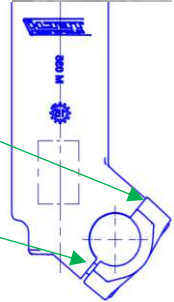

EPURE – ESCAPE FORK

-Tighten both screws clamp at **10Nm with equal distances.**

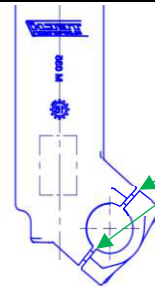

- Fit the mudguard bracket, making sure that it does not have to be forced into place. Tighten to 10 Nm

⚠ Take care to test the performances of the front brake before riding, it is possible that during mounting the front caliper piston should be not ready to brake directly, make some braking with the handlebar lever.

Setting Series

Hydraulic

Spring

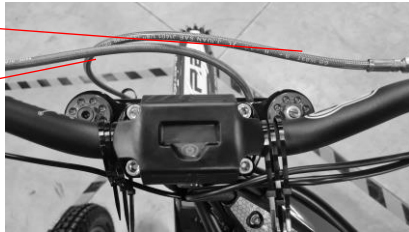

Hydraulic setting

Number of clics	0-11	11-22	22-33
-----------------	------	-------	-------

When adjusting it is best to always close the hydraulic by turning the screw completely and go back to the desired setting. The factory setting is 16.

Setting Spring

	HARD	MEDUIM	FLEXIBLE
Number of turns	0-4	4-7	7-11

The spring setting is adjusted with a 6mm Allen key. When adjusting it is best to always screw completely and then unscrew the desired number of turns, 11 turns allows this adjustment. The factory setting is 6 turns.

11.3 Clean the fork

It is necessary to clean the fork after each use, to avoid any damaged seal.

- Stop the motorcycle (🔗 9.8).
- Put the motorcycle on a stand (wheels in air) (🔗 11.1).
- Lubricate the dust seal protectors,
- Clean the fork tube with clean cloth and install grease.
- Remove the excess of grease.



Absolut forbidden, all aggressive products.



Do not use high pressure water jet directly on the seal.

11.4 Chain tension adjustment

- Bike on a stand
- The upper face of the chain tensioner rubber should be at 25mm from the swingarm.



11.5 Shock absorber setting (*EXCEPT Epure Race*)

11.5.1 Hydraulic setting

Adjustments are made from the right side of the bike and are made on the top of the shock using a 4mm Allen key.

There are 20 adjustment steps for the hydraulics.

	HARD	MEDIUM	FLEXIBLE
Number of clic	0 – 7	7 – 14	14 - 20

When adjusting, it is best to start closing the hydraulics by turning the screw to the stop and then unscrewing it to the desired notch afterwards. The factory setting is 10.

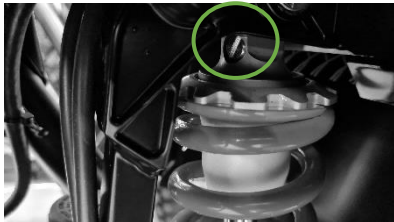

11.5.2 Spring pre-load adjustment

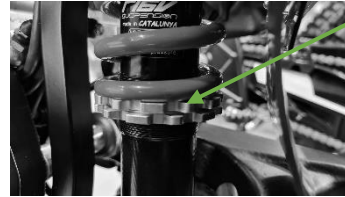

Splined nut

Counter Nut



The rear shock absorber becomes accessible by lifting the rubber flap behind the tyre.

The spring preload is adjusted by turning the spline nut up and down. This nut is locked by a counter nut under it.

11.6 Shock absorber setting (*Epure Race*)

11.6.1 Rebound setting

- This setting is done from the right side of the bike, on the upper part of the shock, with a flat screwdriver.

- There are 50 clicks in total.

	FAST	MEDIUM	SLOW
Number of clicks	30	40	50

When adjusting, it is best to start with closed settings, by turning the screw clockwise to the stop and then unscrewing it to the desired notch afterwards. The factory setting is 32 clicks.



11.6.2 Spring pre-load adjustment

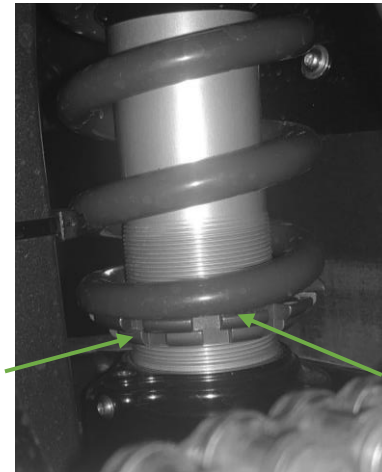

Counter nut

Spline nut

- The rear shock absorber becomes accessible by lifting the rubber flap behind the tyre.
- The spring preload is adjusted by turning the spline nut clockwise or counterclockwise.
- This nut is locked by a counter nut under it.
- It is advised to fully unscrew the nut, then screw it up to contact with the spring. From there, screw it to the required compression length.
- The factory setting is 6mm.

11.7 Removing and refitting the front mudguard

Disassembly

- Stop the vehicle (🔒9.8).
- Raise the motorbike on a stand.
- Remove the fender fixing screws with a 3mm Allen key.



- Remove the front mudguard.

Reassembly

Perform all disassembly actions in reverse order for reassembly,

11.8 Auto-setting

- It is possible to do an auto-setting on the motorcycle, it will calibrate the motor.
- It is advised to do an auto-setting if the user encounter acceleration problems.

For that, please go on our web site and follow the instructions of the auto-setting video for your model:

<https://www.electric-motion.fr/en/my-em-en/instruction-videos>

11.9 ON road display setting

- Install motorcycle on a stand
- Switch ON the battery
- Enter the associated value like below

ELECTRIC MOTION 2023

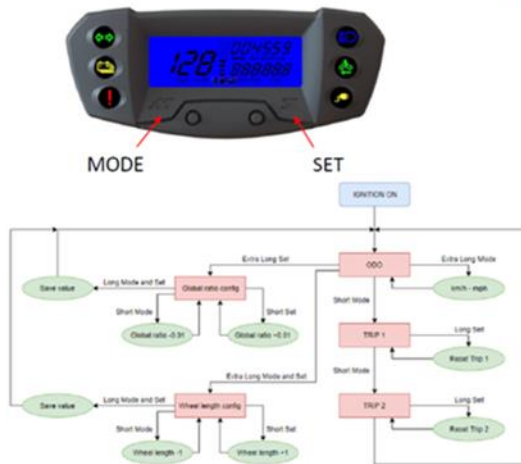

	Transmission	Ratio	Wheel length
EPURE	11 / 57	12,95	2060
ESCAPE	11 / 57	12,95	2060
ESCAPE R	11 / 57	14,39	2060
RACE	11 / 57	14,39	2060
COMP	11/59	14,89	2060

CONFIDENTIAL – PROPERTY OF ELECTRIC MOTION

11.10 Dismantling and reassembling the handlebars



Disassembly

- Stop the vehicle (👉 9.8).
- Raise the motorbike on a stand (👉 11.1111).
- Remove the upper bridge bolts using an 8mm Allen key.



- Take out the handlebars



Reassembly

- Place the handlebars in the lower bridges.
- Place the top brackets and screws on the handlebar.
- Tighten the bolts of the upper bridges to a torque of 14 Nm.



Before riding the motorbike again, make sure that the handlebars are securely fastened as this could cause serious falls.

11.11 Dismantle and reassemble the motorbike cover

- Stop the vehicle (9.8),
- Raise the motorbike on a stand (11.1),
- Remove the headlight plate,
- Remove the front fender (11.7),
- Remove the central cover of the motorbike by unscrewing 1 screw with an 8mm socket,

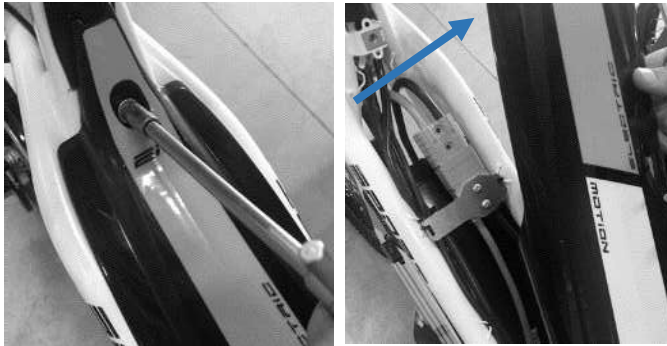

- Remove the rear cover with a 4mm Allen key and unscrew the 4 screws simultaneously

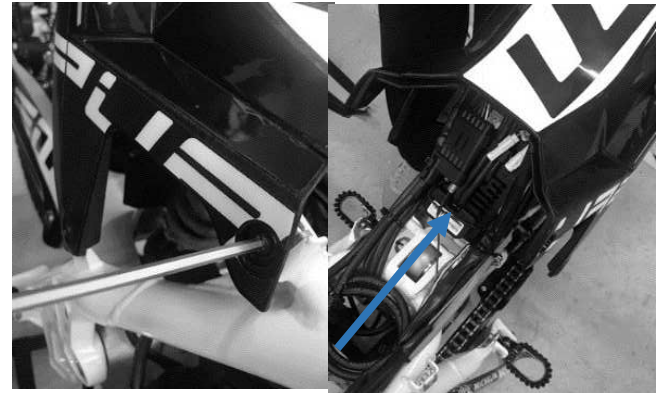

 On a model with a rear LED light option, be sure to disconnect the connector between the controller and the LED:



- Remove the rear mudguard ( 13.3).

Reassembly

Do all the disassembly steps in upside down to reassemble.

11.12 Maintenance

	Check	Changing
Tightening	2 first hour then each 20 Hour	
Clutch oil	20 Hours	40 Hours
Belt + Sprocket bearing	50 Hours	100 Hours
Chain	After each use	

Element	Standard	Utilisation limit
Wheels/tires		
Cold tire pressure For a drive on road	100kPa (1.02kgf/cm ²)	
Only for competition use Front Rear	39-44 kPa (0.40-0.45 kgf.cm ²) 29-34 kPa (0.40-0.35 kgf.cm ²)	-

Tightening (Nm)	
Wheels	
Front wheel axis	40
Fork flange wheel axis	10
Front caliper	20
Rear/Front discs screws	11 + Loctite
Rear wheel axis	60
Steering	
Steering axis	50
Clamp	10
Handlebar clamp	14
Suspensions	
Upper rear shock screw	50
Suspensions connecting rods	30
Swingarm axis	50
Motor	
Clutch diaphragm screws	6
Front transmission screws	25 + Loctite
Lower transmission screw	20
Carter screws	11
Motor/carter screws	20 + Loctite
Rear Sprocket	20

12. Clutch

12.1 Clutch oil maintenance (RACE)

- Remove the battery
- Process can be done with or without the engine plate protector mounted
- Open the filler cap 1

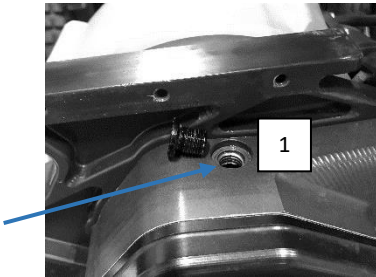

- Open the drain plug 2
- Be careful: the oil will flow, install an oil container**

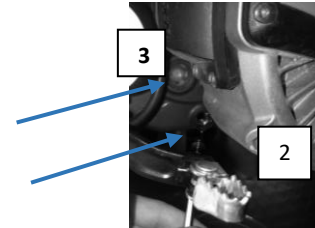

- Wait the complete oil change
- Clean the magnet on the drain plug
- Install again the drain plug with the cooper washer, screw tightening 17Nm
- Fill the transmission with **260 ml of oil 75W**



Recommended oil NLS CLUTCH TRIAL



- Oil level should be on the middle of the oil level indicator 3
- Install again the filler cap 1 with the cooper washer, screw tightening 17Nm
- Install again the battery

Maintenance frequency:

Verify the oil level: each **20 hours**

Change clutch oil: each **40 hours**



INDEX

	A	
Adapt the bike to the driver.....		37
Stop and crouch.....		35

	B	
Braking.....		33, 34

	C	
Charging the battery.....		27
Check before use.....		30
Clean the bike.....		35

	M	
Motor behavior adjustment.....		32

	S	
Security.....		7
Starting the bike.....		31
Storing the bike.....		36

	T	
Technical data.....		15
Top up the brake fluid level.....		67

	U	
Using the vehicle.....		30

	V	
View of the vehicle		
Right view.....		14
Left view.....		14